

Article number: 20192B50B50652SW

Description: E+G

T-angle clamps GN192-B50-B50-65-2-SW

Measures

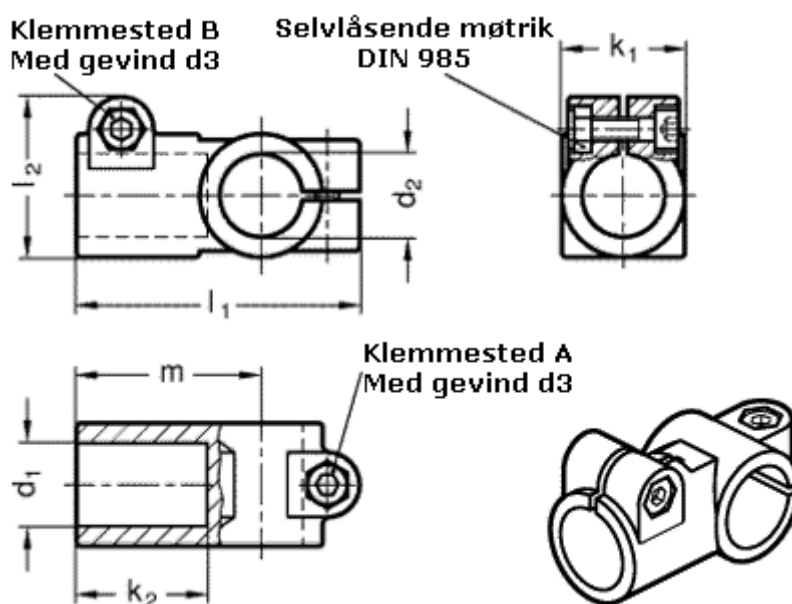

d1 = B50
d2 = B50
d3 = M10
k1 = 65
k2 = 75.0
l1 = 148
l2 = 77.5
m = 103